

Article number: 0102031

Description: Retaining ring J15 DIN472  
Spring steel

## Measures

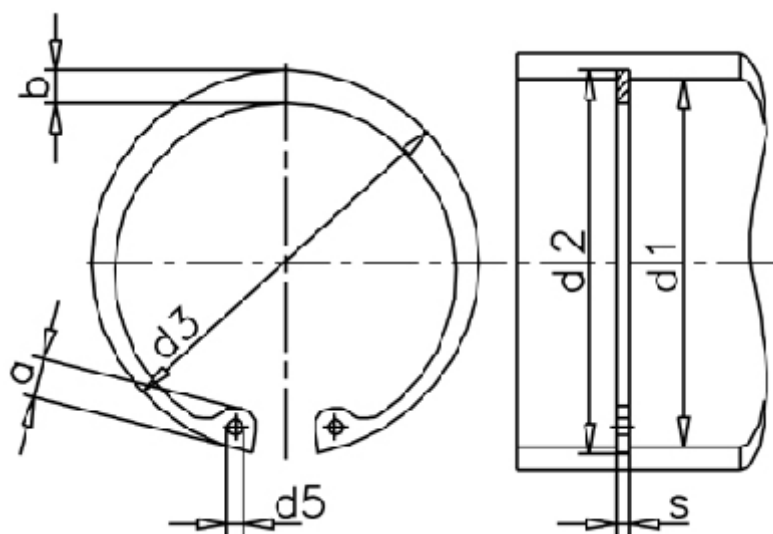

a max	= 3.7	FN kN	= 2.80	t	= 0.35
AN mm <sup>2</sup>	= 16.8	FRg kN	= 2.3	tol	= +0,11
b	= 2.0	FR kN	= 5.0	tol	= +0,36-1,10
d1	= 15	g	= 0.5	tol	= -0.06
d2	= 15.7	K kN-mm	= 19.0	Tong	= ZGJ-1
d3	= 16.20	m min	= 1.10	Weight kg/1000	= 0.56
d5 min	= 1.7	Nominal drive	= 1.1		
Description = J 15		s	= 1.00		